

# Kindergarten

## At-Home Learning

### Day One

- Write the missing letter worksheet- write the beginning sounds of each word
- Blending Practice worksheet- write all of the sounds in the word
- Addition dice worksheet- solve the addition equations
- Longest worksheet- circle the longest object

### Day Two

- Write the missing letter worksheet- write the beginning sounds of each word
- Blending Practice worksheet- write all of the sounds in the word
- Numbers before and after worksheet- write the number that comes before and after each number in the truck
- Drawing shapes worksheet- draw the correct quantity of each shape as listed

### Additional resources provided:

- Sight word flash cards
- Writing paper and list of writing ideas
- The Three Little Pigs story and retelling puppet pieces

### Other learning ideas:

- Read or listen to a story and talk about it
- Count to 100 by ones and 10s
- Help with cooking or baking a recipe
- Go on a shape walk to look for and name shapes
- Play a family board game
- Sort and count beans, cereal pieces, beads, or other objects
- Make letters and words using clay
- Practice telling stories to a family member
- Practice tying shoes

WRITE THE  
Missing Letter

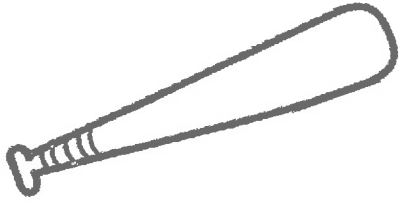

at

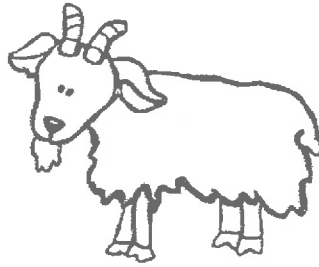

oat

10

en

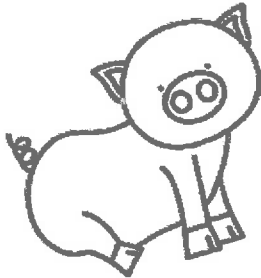

ig



ad

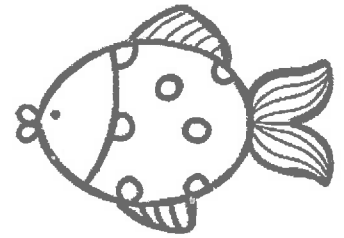

ish



ock



x

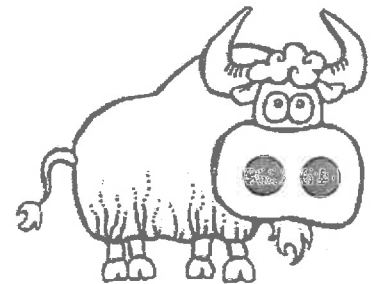

ak

Name: \_\_\_\_\_

# Blending Practice I

1

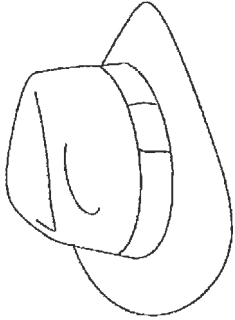

hat

\_\_\_\_\_

2

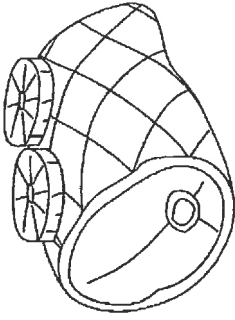

\_\_\_\_\_

3



\_\_\_\_\_

4

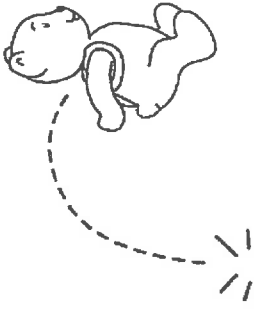

\_\_\_\_\_

5

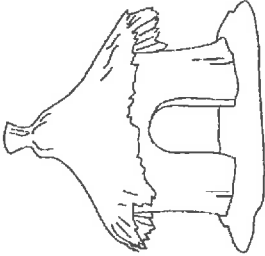

\_\_\_\_\_

6

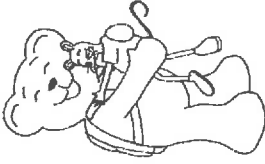

\_\_\_\_\_

7

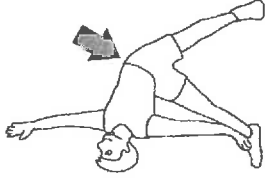

\_\_\_\_\_

8

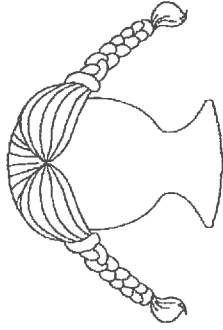

\_\_\_\_\_

Point to each picture and say its name. Then write the name of each picture on the lines provided.

# Addition

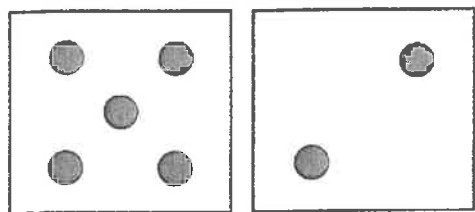

$$5 + 2 = \square$$

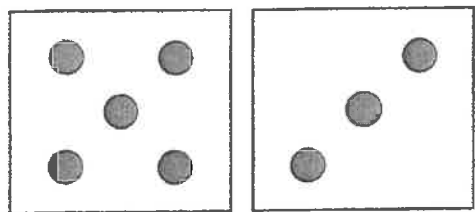
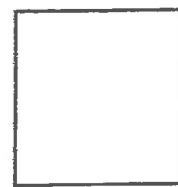

$$5 + 3 = \square$$

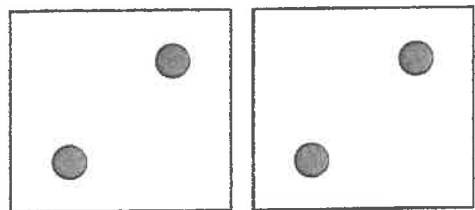
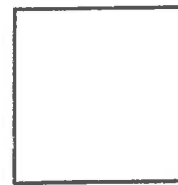

$$2 + 2 = \square$$

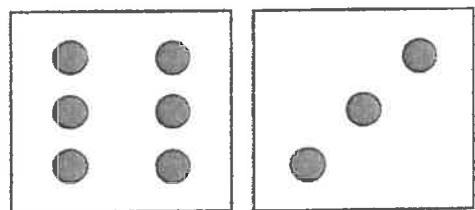
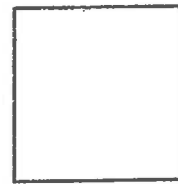

$$6 + 3 = \square$$

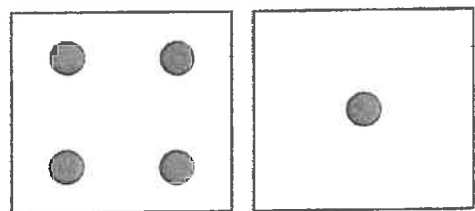
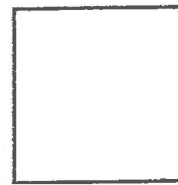

$$4 + 1 = \square$$

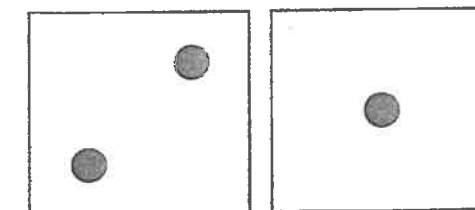
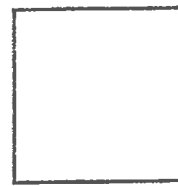

$$2 + 1 = \square$$

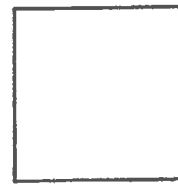

Name: \_\_\_\_\_

# Longest

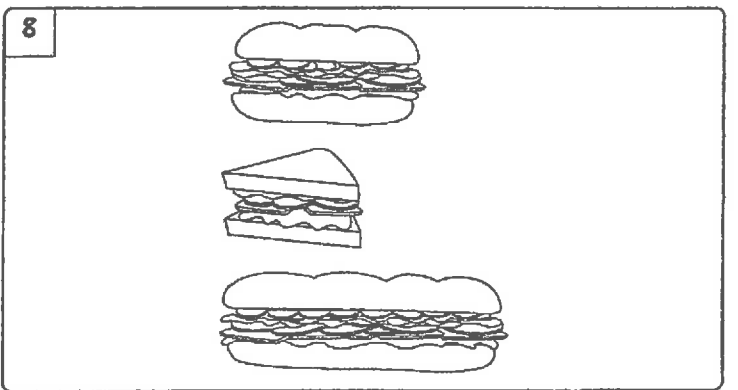
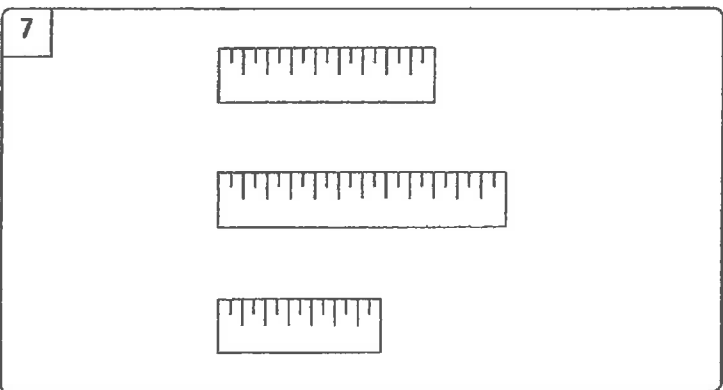
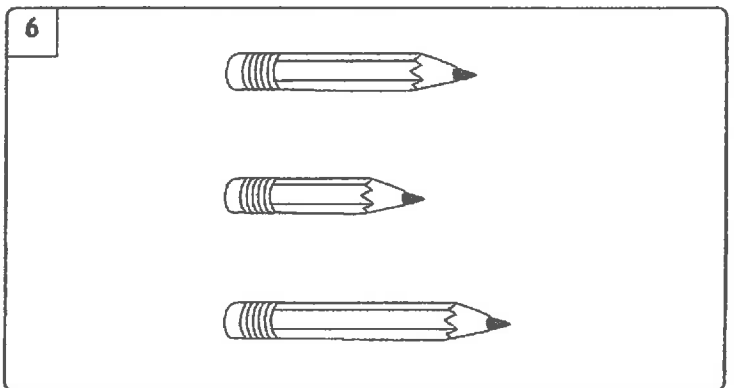
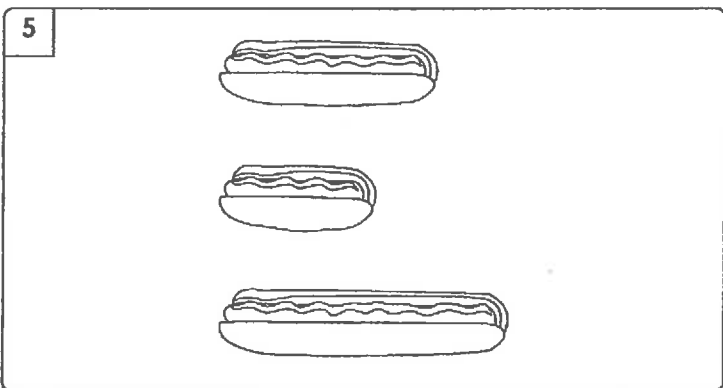
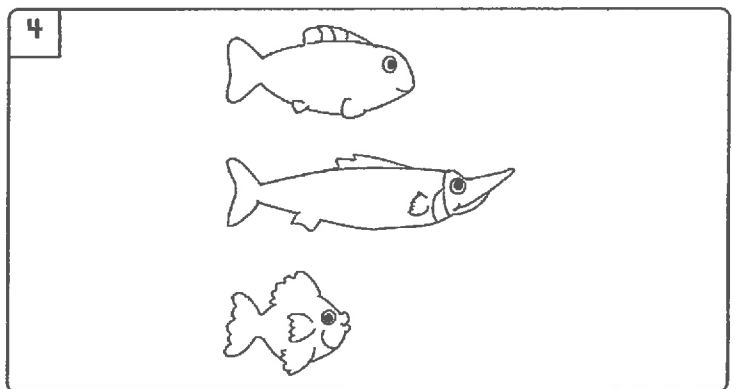
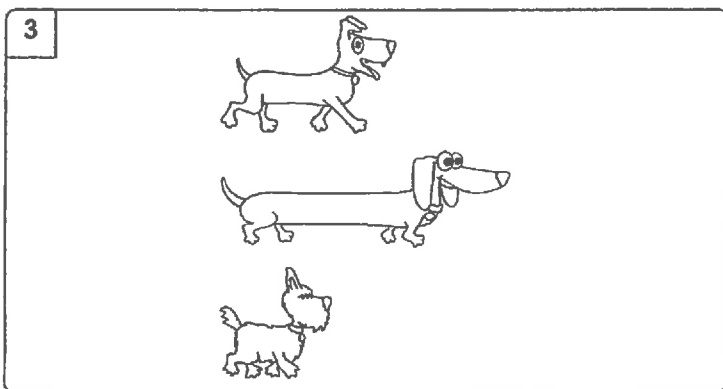
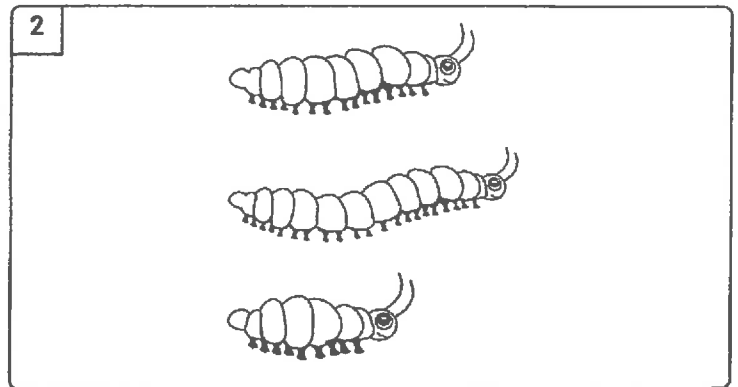
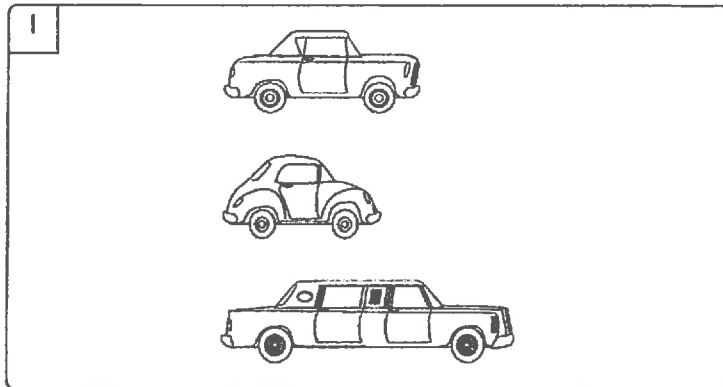

Circle the longest object in each box.

# Write the Missing Letter

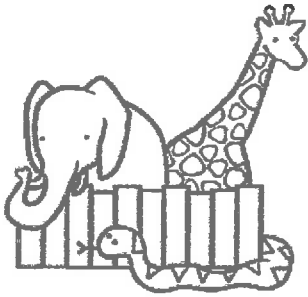

oo

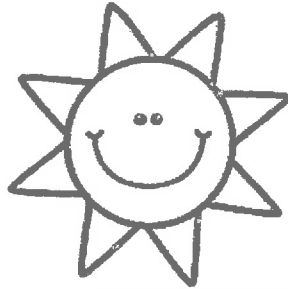

un

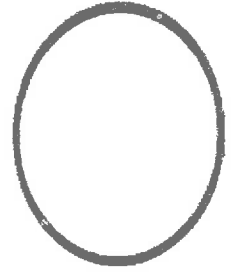

gg

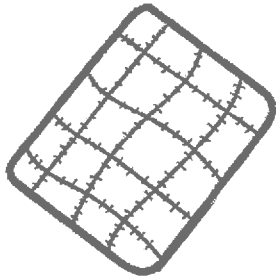

uitt



og

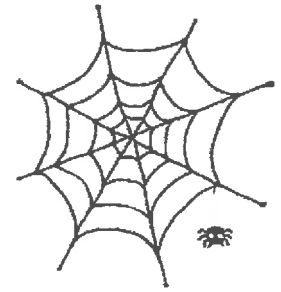

eb



am

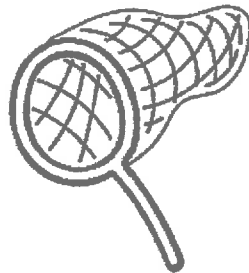

et

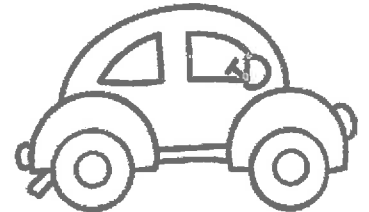

ar

Name: \_\_\_\_\_

COMMON CORE | K.RF.2

# Blending Practice I

1

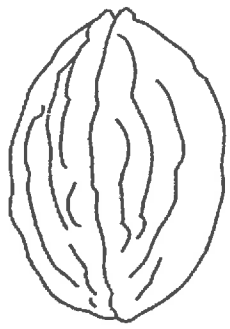

nut

\_\_\_\_\_

2

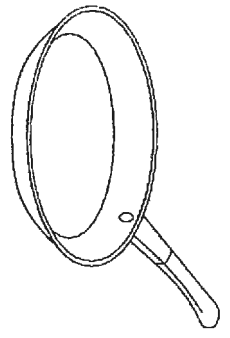

\_\_\_\_\_

3

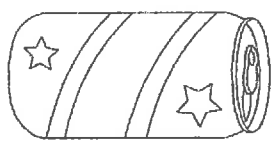

\_\_\_\_\_

4

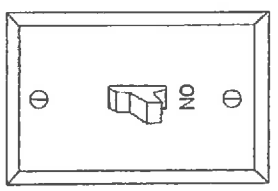

\_\_\_\_\_

5

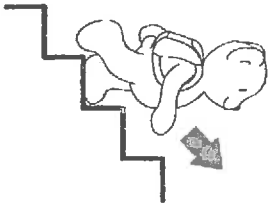

\_\_\_\_\_

6

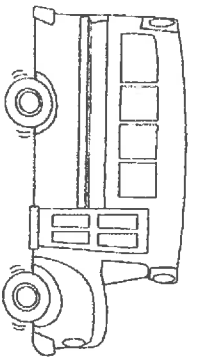

\_\_\_\_\_

7

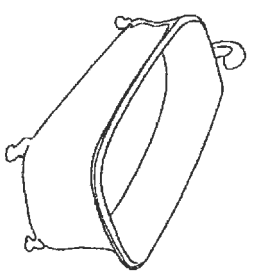

\_\_\_\_\_

8

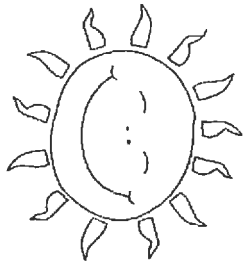

\_\_\_\_\_

Point to each picture and say its name. Then write the name of each picture on the lines provided.

Write the numbers that  
come before and after.

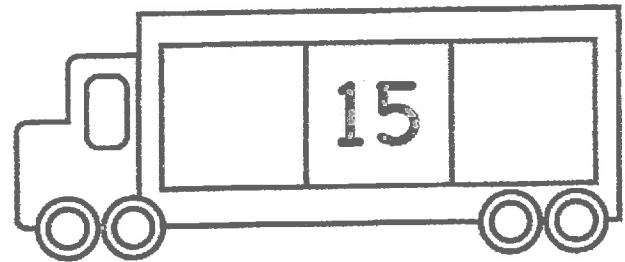
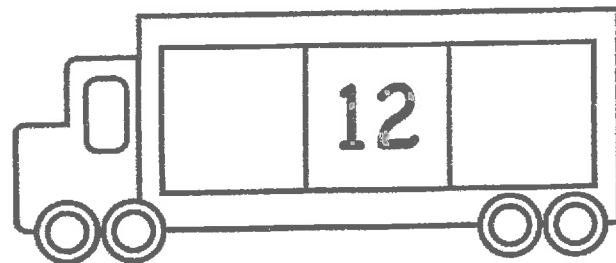
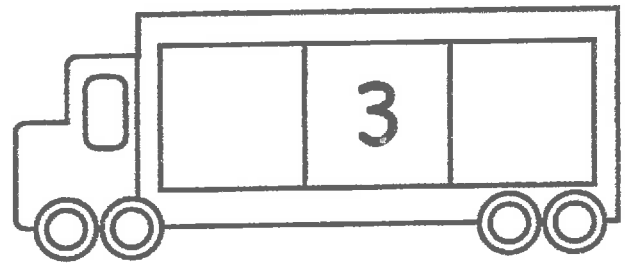
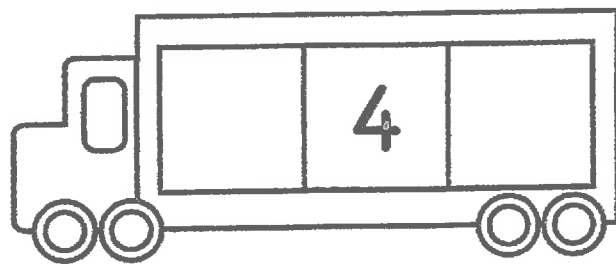
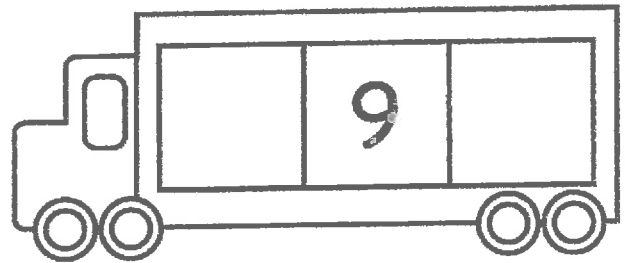
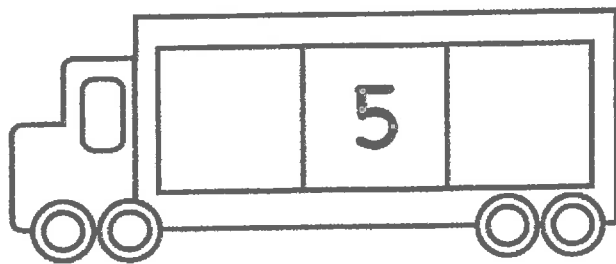
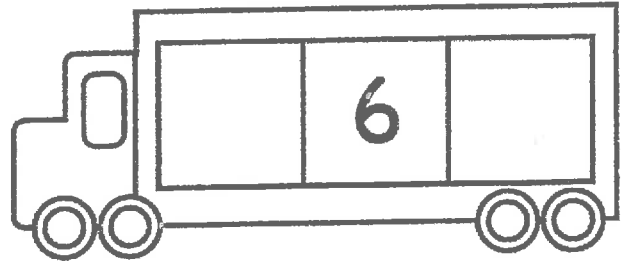
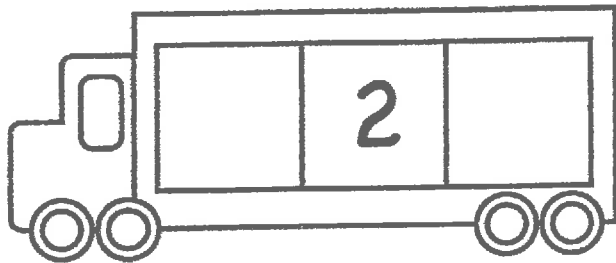
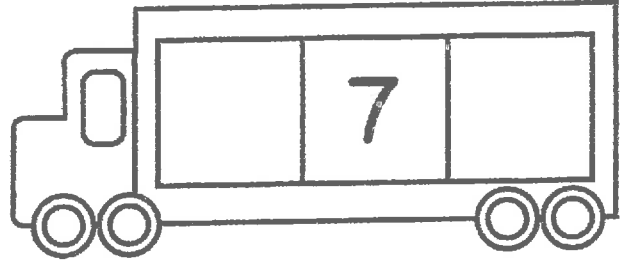
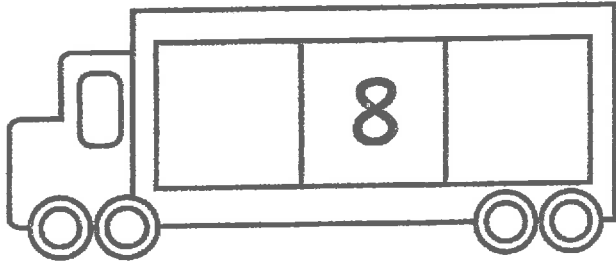



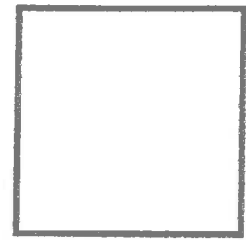
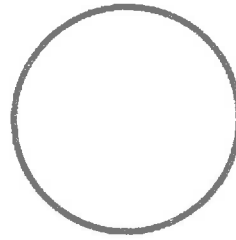
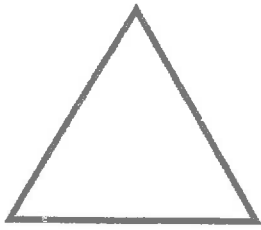

Draw 2 rectangles.

Draw 3 squares.

Draw 3 triangles.

Draw 4 circles.

*What Can I write about?*

*A favorite book*

*Your pet*

*Something you are good at*

*A place you went*

*Your favorite food*

*One of your toys*

*Your family*

*An animal*

*A game you like to play*

*Your friends*

*Your bedroom or house*

*A food you do not like*

*What you want to be when you grow up*

*The weather*

*How to do something*

*Your favorite tv show*

*A movie*

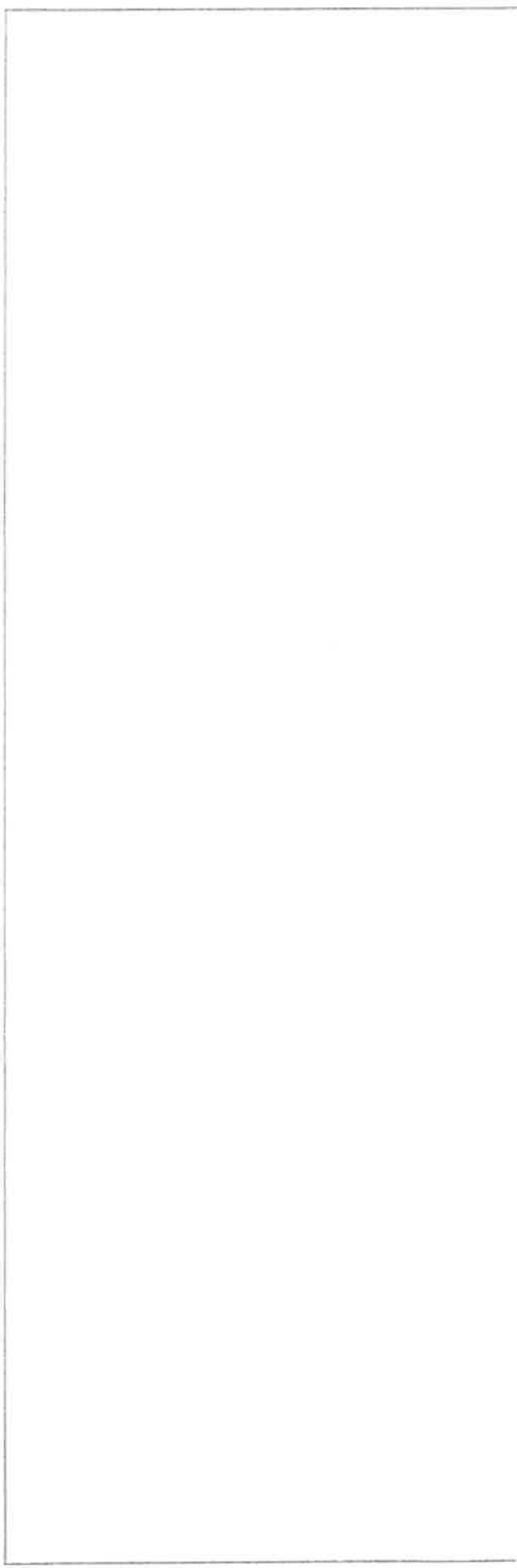

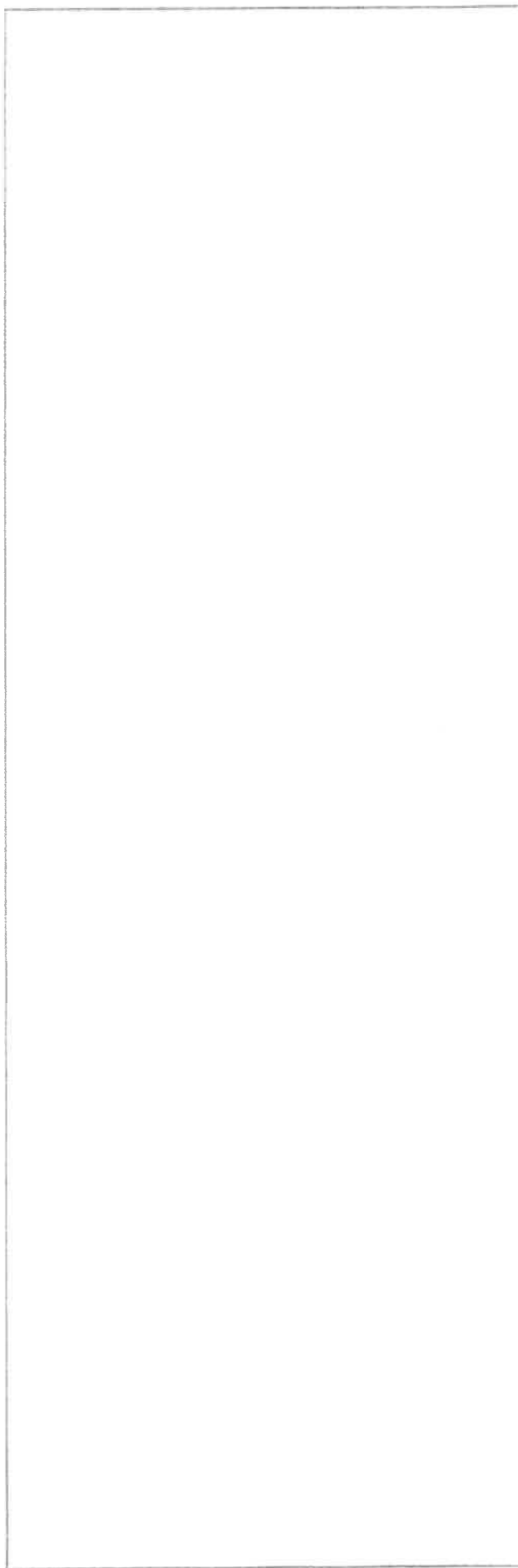
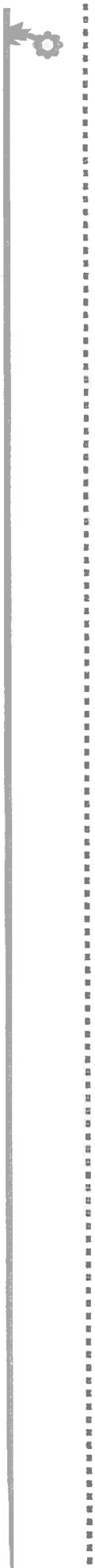

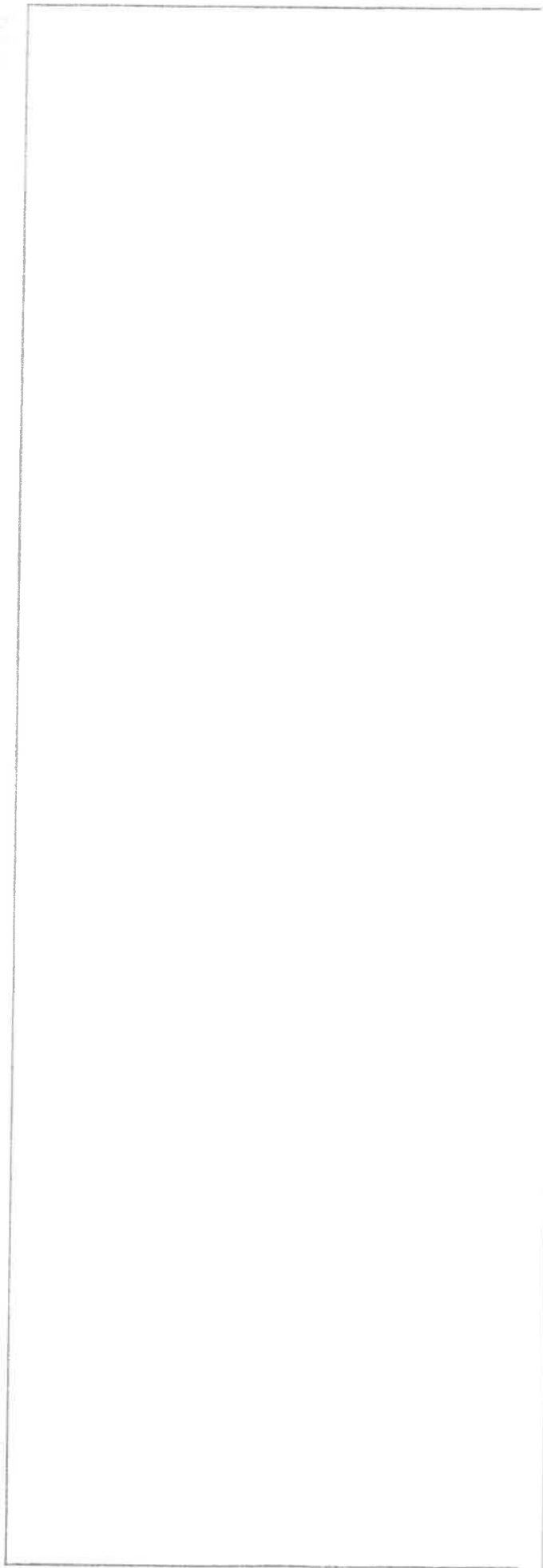
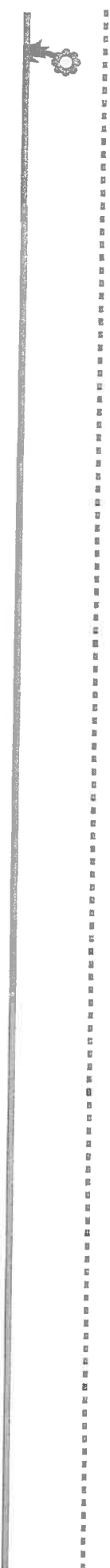
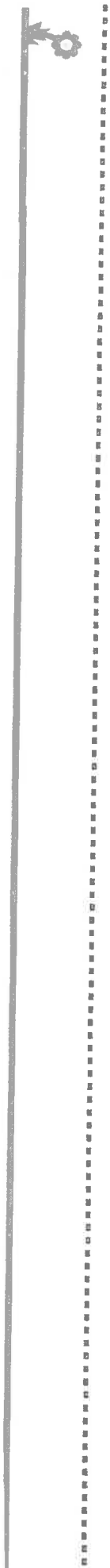







Name: \_\_\_\_\_



Date: \_\_\_\_\_



# The Three Little Pigs

DIRECTIONS: Use the three little pig finger puppets to retell the story!

Once upon a time there were three little  who lived in a village with their mother and father. The time soon came for them to move out.

The first  decided to build a  for herself out of . Soon, a  came walking by. When he saw the first ,

"Little , little , let me come in," he said. "Not by the hair on my chinny chin chin!" replied the .

"Then I'll huff and I'll puff and I'll blow your  down!" growled the , and he began to blow so hard that the straw  blew away!



# The Three Little Pigs

The next  built his  out of . As

he was building away, the same  came by.

"Little , little , let me come in."

"Not by the hair on my chinny chin chin!"

"Then I'll huff and I'll puff and I'll blow your  in!" said the  and he began to blow so hard that the  of sticks blew away!

The third  built his house out of .

Once again, the wolf wandered by.

"Little , little , let me come in."

"Not by the hair on my chinny chin chin!"

# The Three Little Pigs

"Then I'll huff and I'll puff and I'll blow your in!" said the



, and he began to blow as

he had on the first two

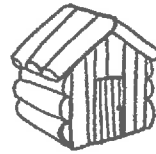

But this

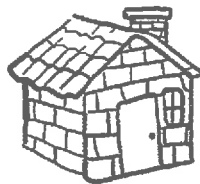

was different. Try as he might,

he couldn't knock the



down! After tiring

himself out, he decided to try and sneak in through

the



Little did he know there was a



of hot

water waiting for him at the bottom! He fell in with

a splash as the



laughed around him.

Embarrassed (and a little sore from the hot water),

the



ran away, never to bother the



again.



# The Three Little Pigs

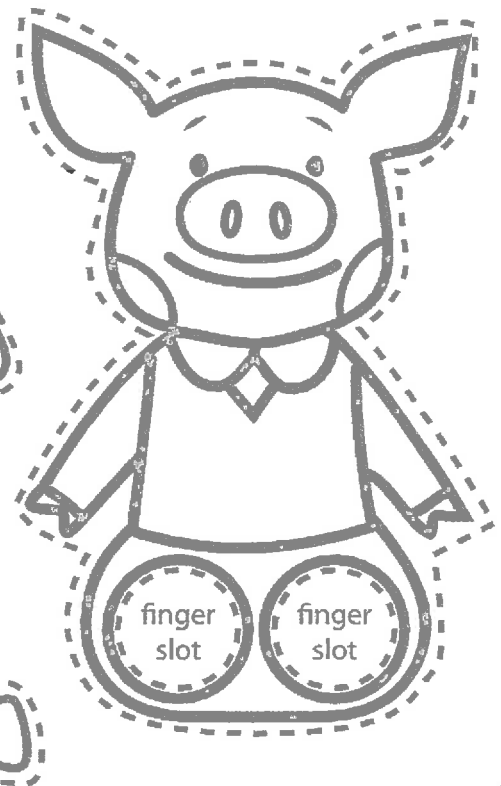
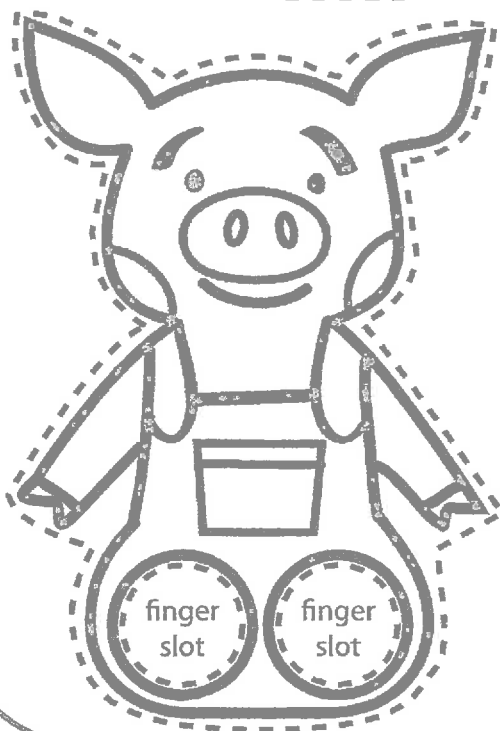
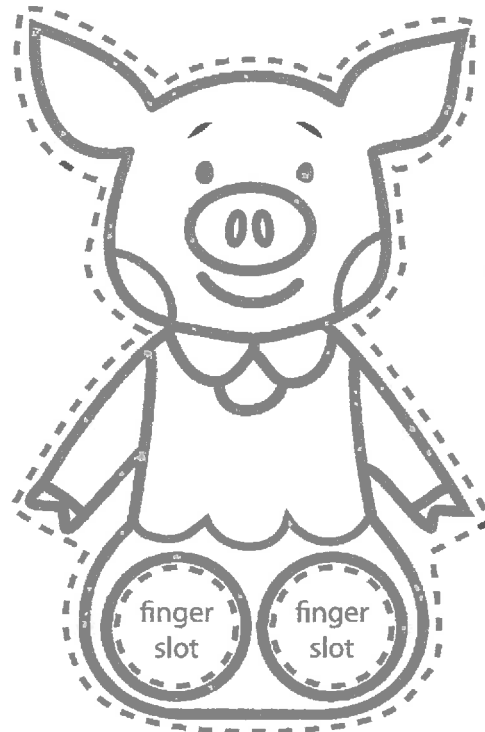
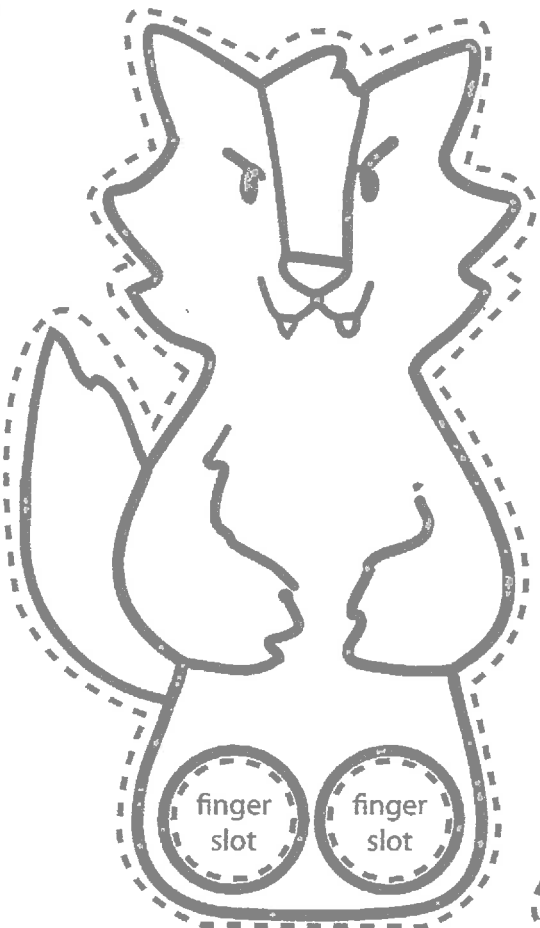

I

a

can

my

the

go

am

to

an

like

at

in

it

is

on

he

she

come

see

be

this

here

me

for

where

do

you

look

one

what

two

will

up

down

yes

no

red

yellow

green

blue

black

white

brown

one

two

three

four

we

want

out

who

are

they

good

has

his



and

there

give

little

that

have

said

of

but

was

her

then

all

with

came

did

get

run

ran

into

must

jump

play

because

some

now

not

say

saw

big

under

so

well

our

us

help

too

soon

away

please

pretty

funny

find

make

ride

new

ate

eat